

USER MANUAL

VENTILATION SYSTEMS FOR RESIDENTIAL USE ONLY



ERV DUO 1.5



ERV DUO 2.0

ADDRESS OF YOUR INSTALLER



7 72371 11860 7



20507 REV. 03

ABOUT THIS MANUAL / PRODUCT

The purpose of this manual is to help you with the use of your unit. Please read every Sections as they contain important information.

We welcome any suggestions you may have concerning this manual and/or the unit, and we would appreciate hearing your comments on ways to better serve you. Please forward all correspondence to us at the address indicated on the product's registration card included with this manual.

This manual uses the following symbols to emphasize particular information:

⚠ WARNING

Identifies an instruction which, if not followed, might cause serious personal injuries including possibility of death.

CAUTION

Denotes an instruction which, if not followed, may severely damage the unit and/or its components.

NOTE: Indicates supplementary information needed to fully complete an instruction.

Finally, we want to congratulate you on your purchase of this excellent unit which will allow you and your family to enjoy fresh air throughout your home for years to come!

CAUTION

Some activities create dust or vapors which may damage your unit. You must therefore turn off and unplug your unit in the following situations:

- Major renovation work
- Sanding (e.g. gypsum joints, etc.)
- Housing construction
- Varnishing

During very heavy snowstorms or rain with strong winds, the unit should also be turned off to avoid problems caused by snow or rain entering the unit, even if it is equipped with an anti-gust intake hood.

At least once a year, the unit mechanical and electronic parts should be inspected by qualified service personnel.

CAUTION

When leaving the house for a long period of time (more than two weeks), a responsible person should regularly check if the unit operates adequately. If the ductwork runs through an unconditioned space (e.g.: attic), the unit must operate continuously except when performing maintenance and/or repair. Also, the ambient temperature of the house should never drop below 18°C (65°F).

REPLACEMENT PARTS AND REPAIRS

In order to ensure your ventilation unit remains in good working condition, you must use Venmar Ventilation ULC genuine replacement parts only. The Venmar Ventilation ULC genuine replacement parts are specially designed for each unit and are manufactured to comply with all the applicable certification standards and maintain a high standard of safety. Any third party replacement part used may cause serious damage and drastically reduce the performance level of your unit, which will result in premature failing. Also, Venmar Ventilation ULC recommends to contact a certified service depot for all replacement parts and repairs.

TABLE OF CONTENTS

1. YOUR UNIT AND ITS PURPOSE.....	4-5
1.1 UNIT DESCRIPTION	4
1.2 PURPOSE OF THE VENTILATION SYSTEM	4
1.3 RECOVERY	5
1.4 DEFROST MODE	5
1.5 SPECIFICATIONS	5
2. CONTROLS	6
2.1 INTEGRATED CONTROL.....	6
2.2 BOOT SEQUENCE	6
2.3 OPTIONAL MAIN AND AUXILIARY CONTROLS	6
3. MAINTENANCE	7-8
4. TROUBLESHOOTING	8

1. YOUR UNIT AND ITS PURPOSE

1.1 UNIT DESCRIPTION

1. Filters
2. Blower
3. Thermal wheel

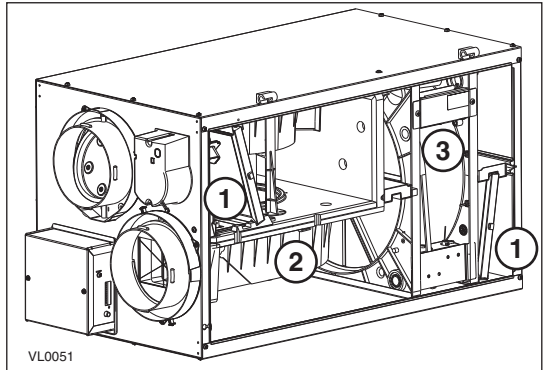

Units shown in normal position. Can also be installed upside down.

1.2 PURPOSE OF THE VENTILATION SYSTEM

Your ventilation system is designed to provide fresh air, warmed outdoor air to your home while exhausting stale, humid air from your home. By eliminating accumulated pollutants and humidity, it maintains an optimum air quality and an ideal relative humidity.

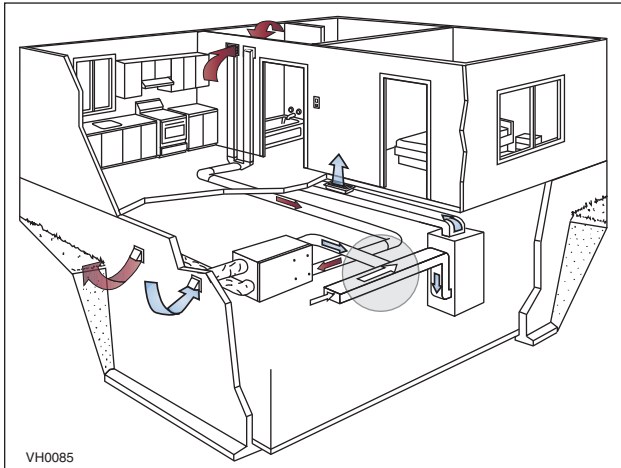

- NOTES:
1. Shown with a forced air system. Can also operate on its own.
 2. Installation may vary according to the model number and the position (normal or reverse) in which the unit is installed.

1. YOUR UNIT AND ITS PURPOSE (CONT'D)

1.3 RECOVERY

Your ventilation system is equipped with a thermal wheel that can reduce ventilation costs in winter as well as in summer by maintaining indoor humidity level for maximum comfort.

1. During heating season, the unit draws humidity and heat from the stale air and transfers them, in part, to the cold air entering the house, thus avoiding dryness problems and providing maximum comfort (Example 1).
2. During cooling season, the unit reverses the process, preventing humidity from the outdoor air from entering the house (Example 2).

EXAMPLE 1 (IN WINTER)

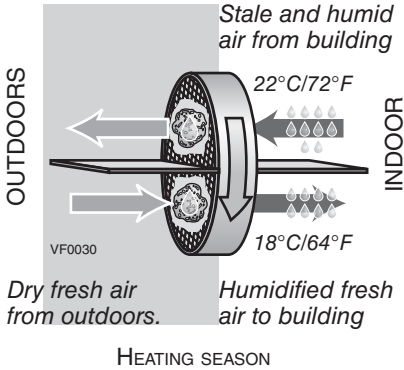

EXAMPLE 2 (IN SUMMER WITH AIR CONDITIONING)

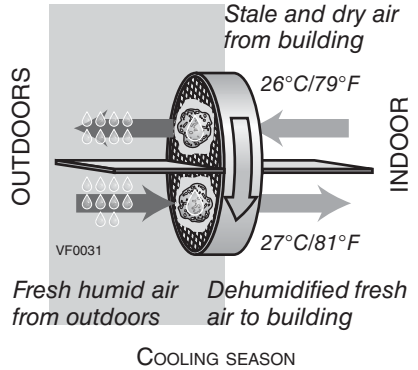

1.4 DEFROST MODE

When the outdoor temperature is below -5°C (23°F), energy recovery creates frost in the module. To maintain its proper operation, the unit is programmed to defrost the recovery module. The defrost frequency varies according to the outdoor temperature. Defrost lasts 9 minutes (or 10 minutes if set on "Extended Defrost"). During the defrost cycle, the unit shifts to maximum speed and the dampers close.

After defrosting, the unit returns to the operating mode selected by the user.

1.5 SPECIFICATIONS

MODEL	Duo 1.5	Duo 2.0
WIDTH	30¼"	30¼"
HEIGHT	16½"	16½"
DEPTH	17⅛"	17⅛"
WEIGHT	73 LB. (33 KG)	73 LB. (33 KG)
ELECTRICAL SUPPLY	120 V, 60 Hz	120 V, 60 Hz
POWER CONSUMPTION	170 WATTS	230 WATTS

2. CONTROLS

2.1 INTEGRATED CONTROL

These units are equipped with an integrated control, located on the electrical compartment. Use the push button (1) to control the unit. The LED (2) will then show on which mode the unit is in.

- NOTES:
1. The integrated control **must be turned OFF** to use an optional main control.
 2. If an optional auxiliary control is used, if activated, this auxiliary control will override the optional main control operation.

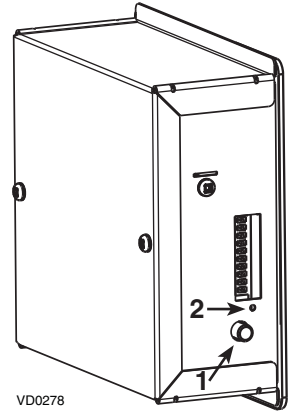

Refer to table below.

LED COLOR	RESULTS
AMBER	UNIT IS ON LOW SPEED
GREEN	UNIT IS ON HIGH SPEED
NO LIGHT	UNIT IS OFF OR CONTROLLED BY A MAIN CONTROL



2.2 BOOT SEQUENCE

The unit boot sequence is similar to a personal computer boot sequence. Each time the unit is plugged after being unplugged, or after a power failure, the unit will perform a 30-second booting sequence before starting to operate. During the booting sequence, the integrated control LED will light GREEN or AMBER for 5 seconds, and then will shut off for 2 seconds. After that, the LED will light RED for the rest of the booting sequence. During this RED light phase, the unit is checking and resetting the motorized damper position. Once the motorized damper position completely set, the RED light turns off and the booting sequence is done.

NOTE: No command will be taken until the unit is fully booted.

2.3 OPTIONAL MAIN AND AUXILIARY CONTROLS

For more convenience, these units can also be controlled using an optional main control. Only one main control can be connected per unit.

CAUTION

Turn off the integrated control and wait until its LED is turned off before using an optional main wall control.

NOTE: If an optional auxiliary control is used, its activation will override the main control operation. For more information about your unit controls, refer to the *Main and auxiliary wall controls user guide* (included with your unit and also available at www.venmar.ca).

3. MAINTENANCE

⚠ WARNING

Dangerous voltage may be present. During maintenance and repairs, the unit must always be turned off, then unplugged.

We take great care to minimize sharp edges; however, please proceed with caution when handling all components.

When cleaning the unit, it is recommended to wear safety glasses and gloves.

Regular maintenance should be performed every 3 months.

NOTE: Unit is shown in normal position but can be installed in either the “normal” or “reverse” (upside down) position.

1. Disconnect power supply.

2. Unlatch the door. Lift the panel towards you. Hold it firmly and hit on the right side of the panel. The door will slide to the left.

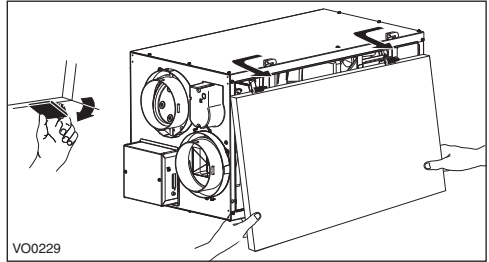

3. Clean the inside of the door with a damp cloth.

4. Clean filters

- Remove filters.
- Vacuum to remove most of the dust.
- Wash with a mixture of warm water and mild soap. You may add bleach if you wish to disinfect (one tablespoon per gallon). Rinse thoroughly. Shake filters to remove excess water and let dry.

5. Clean thermal wheel and blower assembly.

- Remove dust using a vacuum cleaner with a soft brush attachment.

6. Clean the interior of the unit with a damp cloth.

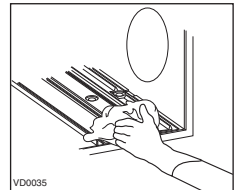

3. MAINTENANCE (CONT'D)

7. Check the exterior air intake hood:
- Make sure there are no leaves, twigs, ice or snow that could be drawn into the vent.
 - Clean if necessary.

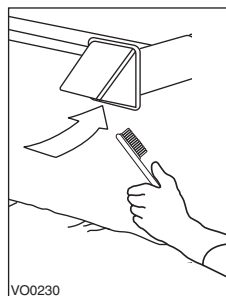

CAUTION

Even a partial blocking of this air vent could cause the unit to malfunction.

8. Reassemble the components:
- Filters
 - Door (the door is secured when you hear a click.)
9. Reconnect power supply.

4. TROUBLESHOOTING

PROBLEM	YOU SHOULD TRY THIS
1. Nothing works.	<ul style="list-style-type: none"> • See if the unit is plugged in. • See if the unit is receiving power from the house circuit breaker or fuse.
2. Noisy unit.	<ul style="list-style-type: none"> • Clean the unit (see Section 3). If the problem is not solved, contact your installer.
3. Condensation on windows (air too humid).	<ul style="list-style-type: none"> • Operate the unit at maximum speed (MAX.) during activities generating excess humidity (family gatherings, extra cooking, etc.). • Leave curtains half-open to allow air circulation. • Store all firewood in a closed room with a dehumidifier or in a well ventilated room, or store the wood outdoors. • Keep the temperature in your house above 18°C (64°F).
4. Air too dry.	<ul style="list-style-type: none"> • Operate the unit at low speed (MIN.). • Temporarily switch to the intermittent mode (if available). • Temporarily use a humidifier.
5. Air too cold at the air supply grille.	<ul style="list-style-type: none"> • Make sure the outdoor hoods are not blocked. • Operate the unit at low speed (MIN.). • Have the system's balancing checked. • Have the unit's defrost system checked. • Install a duct heater.

For wall controls problems, refer to the Troubleshooting section in the *Main and auxiliary wall controls user guide* (included with the ventilation unit and also available at www.venmar.ca).

If the problem is still not solved, call your installer or the nearest approved Service Center. You can also reach the Customer Service Department at the following phone number:
1-800-567-3855.