USER GUIDE

HEAT RECOVERY VENTILATORS MODELS AVS HRV EKO 1.5, AVS CONSTRUCTO 1.5V, NOVOFIT 1.0 AND ENERGY RECOVERY VENTILATOR MODEL AVS ERV EKO 1.5



VB0122



VB0123



VB0126



VB0136

PLEASE READ AND SAVE THESE INSTRUCTIONS

Venmar Ventilation inc., 550 Lemire Blvd., Drummondville, QC, Canada J2C 7W9
www.venmar.ca



These products earned the ENERGY STAR® by meeting strict energy efficiency guidelines set by Natural Resources Canada and the US EPA. They meet ENERGY STAR requirements only when used in Canada.

Congratulations!

You have made an excellent choice! The operating principle of your Heat Recovery Ventilator or your Energy Recovery Ventilator will give you personal comfort you have never known before.

We have prepared this User Guide especially for you. Please read it carefully to ensure you obtain full benefit from your unit. Over the coming months, you will increasingly appreciate the feeling of living in a more comfortable house.

Please take note that this manual uses the following symbols to emphasize particular information:

⚠ WARNING

Identifies an instruction which, if not followed, might cause serious personal injuries including possibility of death.

CAUTION

Identifies an instruction which, if not followed, may severely damage the unit and/or its components.

NOTE: Indicates supplementary information needed to fully complete an instruction.

We welcome any suggestions you may have concerning this guide and/or the unit, and we would appreciate hearing your comments on ways to better serve you.

Please forward all correspondence to us at the address indicated on the product registration card included with this guide.

CAUTION

Make sure at all times that the outside intake and exhaust hoods are free from any snow during the winter season. It is important to check your unit during a big snow storm, so it doesn't draw in any snow. If this is the case, please operate the unit in the recirculation mode, or turn it OFF for a few hours.

Do not use your unit during construction or renovation of your house or when sanding drywall. This type of dust may damage your system.

Since the electronic control system of the unit is incorporated with a microprocessor, it may not operate correctly because of external noise or very short power failure. If this happens, unplug the unit and wait approximately 10 seconds. Then, plug the unit in again.

TABLE OF CONTENTS

1. DEFROSTING MODE	4
2. CONTROLS	4-17
2.1 BOOTING SEQUENCES	4
2.2 INTEGRATED CONTROL	5
2.3 ALTITUDE MAIN CONTROL	6-11
2.4 DECO-TOUCH MAIN CONTROL	12-14
2.5 LITE-TOUCH CONSTRUCTO MAIN CONTROL	15
2.6 CONSTRUCTO MAIN CONTROL	16
2.7 OPTIONAL AUXILIARY CONTROLS	16-17
2.7.1 20-MINUTE LIGHTED PUSH BUTTON	16
2.7.2 20/40/60-MINUTE PUSH-BUTTON TIMER	17
2.7.3 DEHUMIDISTAT	17
2.7.4 60-MINUTE CRANK TIMER	17
3. MAINTENANCE	18-19
3.1 SEMI-ANNUAL MAINTENANCE	18-19
3.2 ANNUAL MAINTENANCE	19
4. TROUBLESHOOTING	19-20

1. DEFROSTING MODE

When the outside temperature is below -5°C (23°F), recovery of heat in HRV units creates frost in the core. For ERV units, when the outside temperature is below -10°C (14°F), recovery of energy creates frost in the core.

To maintain its proper operation, the unit is programmed to defrost the recovery core. The defrost frequency varies according to the outside temperature.

During the defrost cycle, the unit shifts to maximum speed and the dampers close.

After defrosting, the unit returns to the operating mode selected by the user.

2. CONTROLS

2.1 BOOTING SEQUENCES

BOOTING SEQUENCE (HRV EKO 1.5 AND ERV EKO 1.5 ONLY)

The unit booting sequence is similar to a personal computer booting sequence.

Each time the unit is plugged after being unplugged, or after a power failure, the unit will perform a 30-second booting sequence before starting to operate.

During the booting sequence, the integrated control LED will light AMBER for 10 seconds.

After that, the LED will light RED for the rest of the booting sequence. During this RED light phase, the unit is checking and resetting the motorized damper position.

Once the motorized damper position completely set, the RED light turns off and the booting sequence is done.

NOTE: No command will be taken until the unit is fully booted.

BOOTING SEQUENCE (CONSTRUCTO 1.5V AND NOVOFIT 1.0 ONLY)

The unit booting sequence is similar to a personal computer booting sequence.

Each time the unit is plugged after being unplugged, or after a power failure, the unit will perform a 30-second booting sequence before starting to operate.

During the booting sequence, the integrated control LED will light GREEN (unit set in normal defrost) or AMBER (unit set in extended defrost) for 5 seconds, and then will shut off for 2 seconds. After that, the LED will light RED for the rest of the booting sequence.

During this RED light phase, the unit is checking and resetting the motorized damper position. Once the motorized damper position completely set, the RED light turns off and the booting sequence is done.

NOTE: No command will be taken until the unit is fully booted.

2. CONTROLS (CONT'D)

2.2 INTEGRATED CONTROL

All units are equipped with an integrated control, located under the unit, on the recessed side of electrical compartment. Plug the unit. Use the push button (1) to control the unit. The LED (2) will then show on which mode the unit is in.

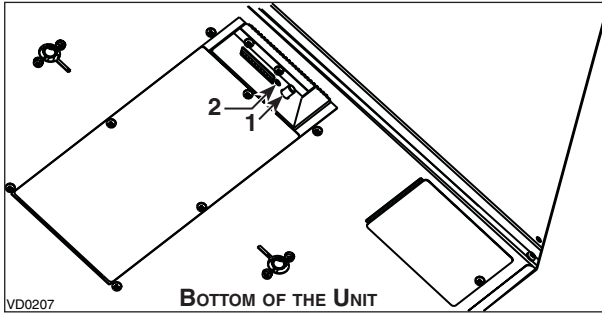

Refer to table below to see how to operate the unit using its integrated control.

PRESS ON PUSH BUTTON	LED COLOR	RESULTS
ONCE	AMBER	UNIT IS ON LOW SPEED
TWICE	GREEN	UNIT IS ON HIGH SPEED
THREE TIMES	NO LIGHT	UNIT IS OFF

If a problem occurs during the unit operation, its integrated control LED (2) will blink. The color of the blinking light depends on the type of error detected. Refer to Section 4 Troubleshooting on last page for further details.

NOTE: When using main control, the integrated control must be turned off.

2. CONTROLS (CONT'D)

2.3 ALTITUDE MAIN CONTROL (FOR AVS HRV EKO 1.5, AVS ERV EKO 1.5 AND NOVOFIT 1.0 UNITS ONLY)

For more convenience, these units can also be controlled using a main control.
Only one main control can be connected per unit.

NOTES: 1. The integrated control must be turned OFF to use a main control.
2. If an optional auxiliary control is used, if activated, this auxiliary control will override the optional main control.

ALTITUDE WALL CONTROL KEYS AND INDICATORS

MODE/PREF KEY



Press this key to select whether Ventilation mode (air exchange with the outside), Recirculation mode (air recirculation within the house) or Program mode (the operation of the ventilation unit is customized by the user. Refer to **HOW TO SET PERIODS FOR PROGRAM MODE** section).



Press and hold this key for 3 seconds to access Preference setting menu.

ARROW KEYS

Use the arrow keys to:

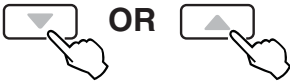

- Select ventilation and recirculation speeds.
- Review the programmed periods.
- Select Preference and Program values.

8 SEC.



Press on Up arrow key for 8 seconds to display interior relative humidity level (in percentage).

SET KEY



Press and hold this key for 3 seconds to access setting periods for Program Mode.

Press this key to confirm the chosen option and go to the following setting.

SMART KEY

Press this key to enable and disable the SMART mode.



The SMART mode uses indoor relative humidity level and minimum and maximum outside temperature values to manage the air exchange with the outside, in order to enhance comfort in the house.

2. CONTROLS (CONT'D)

2.3 ALTITUDE MAIN CONTROL (FOR AVS HRV EKO 1.5, AVS ERV EKO 1.5 AND NOVOFIT 1.0 UNITS ONLY) (CONT'D)

ALTITUDE WALL CONTROL KEYS AND INDICATORS (CONT'D)

POWER INDICATOR

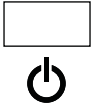

This indicator, located in the upper left side of the wall control, illuminates when the control powered on.

FILTER MAINTENANCE INDICATOR



FILTER

This indicator, located in the upper right side of the wall control, illuminates when it is time to perform the ventilation unit filter maintenance (refer to the ventilation unit user guide).

Once the filter maintenance is done, reset the filter maintenance indicator as follow:

BOTH DURING **5 SEC.**

MODE
PREF



SET



Press simultaneously on both MODE/PREF key and SET key for 5 seconds to turn off the filter maintenance indicator light.

2. CONTROLS (CONT'D)

2.3 ALTITUDE MAIN CONTROL (FOR AVS HRV EKO 1.5, AVS ERV EKO 1.5 AND NOVOFIT 1.0 UNITS ONLY) (CONT'D)

HOW TO SET PREFERENCES

In order to benefit from all of the features of your wall control, the preferences must be set. Table below shows all available settings.

SETTING	AVAILABLE VALUES	DEFAULT OPTION
CURRENT DAY	MON/TUE/WED/THU/FRI/SAT/SUN	MON
HOUR DISPLAY	12:00 ^{AM} OR 24:00 ^{PM}	12:00 ^{AM} ^{PM}
CURRENT HOUR	FROM 0 TO 12 OR 24	12
CURRENT MINUTE	FROM 00 TO 59	00
TEMPERATURE UNIT	°C OR °F	°C
INSIDE TEMPERATURE DISPLAY	ON OR OFF	ON
MINIMUM OUTSIDE TEMPERATURE FOR AIR EXCHANGE*	-40°C TO 0°C OR -40°F TO 32°F	-25°C OR -13°F
MAXIMUM OUTSIDE TEMPERATURE FOR AIR EXCHANGE*	1°C TO 40°C OR 33°F TO 104°F	27°C OR 81°F
*IN PROG OR SMART MODE, THESE LIMIT VALUES ALLOW TO STOP AIR EXCHANGE WITH THE OUTSIDE FOR BETTER COMFORT IN THE HOUSE.		
BACKLIGHT COLOR	BLUE OR GREEN	BLUE
BACKLIGHT DISPLAY	AUTO OR ON	AUTO
AUTO: BACKLIGHT ACTIVATED 10 SECONDS WHEN ANY KEY IS PRESSED. ON: BACKLIGHT ALWAYS ON.		
OFF MODE FOR INTERMITTENT MODE	VENTILATION/RECIRCULATION OR VENTILATION/OFF	VENT/RECIRC.
AFTER A VENTILATION PERIOD, DETERMINES THE SECOND PART OF THE CYCLE (RECIRCULATION OR OFF).		

2. CONTROLS (CONT'D)

2.3 ALTITUDE MAIN CONTROL (FOR AVS HRV EKO 1.5, AVS ERV EKO 1.5 AND NOVOFIT 1.0 UNITS ONLY) (CONT'D)

SETTING PREFERENCES PROCEDURE

NOTE: While setting Preferences, the corresponding setting value flashes (e.g.: while setting current hour, hour is flashing).

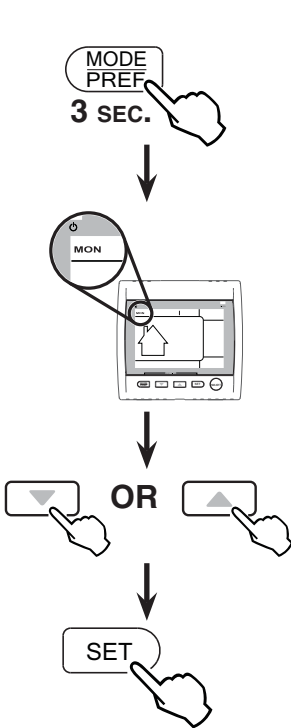

Press and hold MODE/PREF key for 3 seconds to access the setting menu.

NOTE: You can exit Preferences setting by pressing on MODE/PREF for 3 seconds any time in the process, or wait 60 seconds. The modified values will be kept in memory.

If the control is set for the very first time, the current day will be the first setting to be made: MON (for Monday) will flash on screen.

Use the arrow keys to select value.

Press SET key to confirm the selected preference and go to next setting.

HOW TO SET PERIODS FOR PROGRAM MODE

The Program Mode allows the user to customize the operation of his/her ventilation unit, for week and weekend days. All days are divided in 4 periods. The periods starting hour and ventilation speed are factory set (see below).

DAILY PERIODS DEFAULT SETTINGS		
PERIOD	STARTING HOUR	MODE
PERIOD 1 (MORNING)	6:00 AM	MIN
PERIOD 2 (DAY)	9:00 AM	20 MIN/H
PERIOD 3 (EVENING)	5:00 PM	MIN
PERIOD 4 (NIGHT)	11:00 PM	20 MIN/H

2. CONTROLS (CONT'D)

2.3 ALTITUDE MAIN CONTROL (FOR AVS HRV EKO 1.5, AVS ERV EKO 1.5 AND NOVOFIT 1.0 UNITS ONLY) (CONT'D)

HOW TO SET PERIODS FOR PROGRAM MODE (CONT'D)

TO CHANGE THESE VALUES:

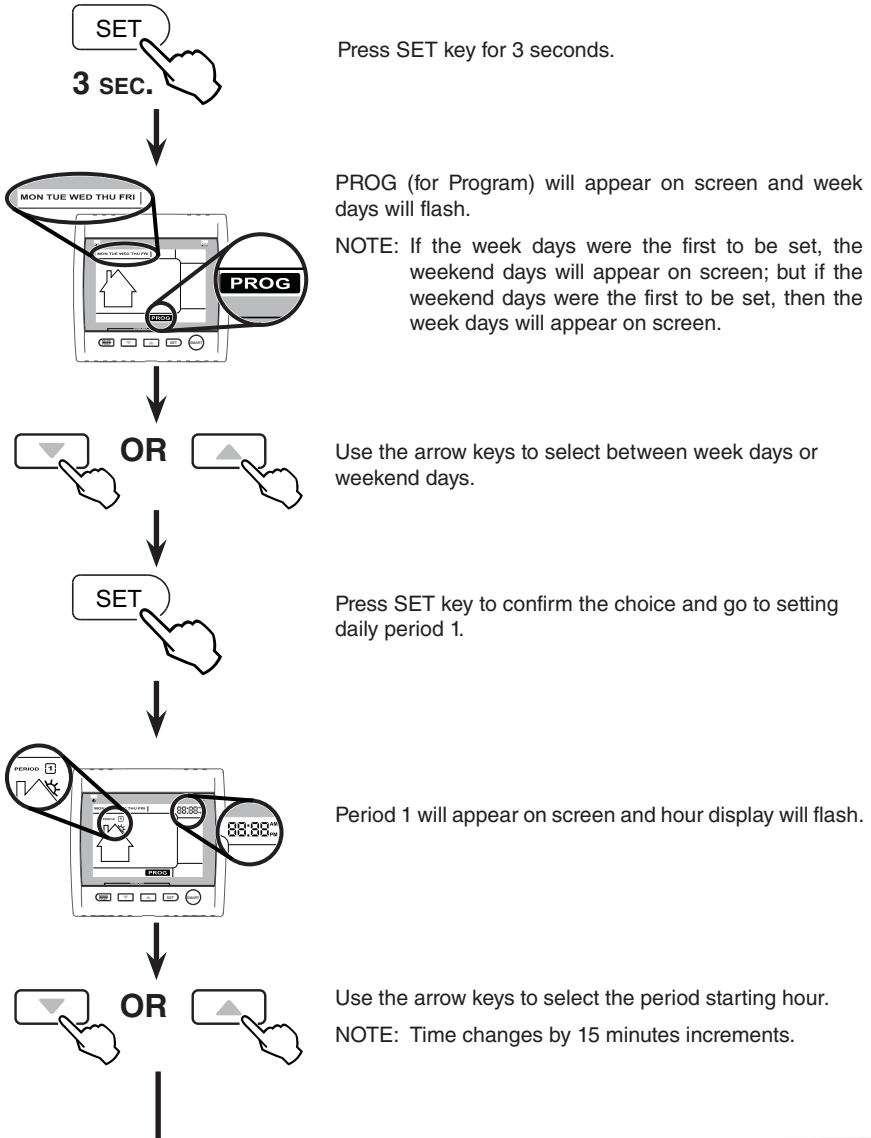

2. CONTROLS (CONT'D)

2.3 ALTITUDE MAIN CONTROL (FOR AVS HRV EKO 1.5, AVS ERV EKO 1.5 AND NOVOFIT 1.0 UNITS ONLY) (CONT'D)

HOW TO SET PERIODS FOR PROGRAM MODE (CONT'D)



Press SET key to confirm the choice and go to select the ventilation speed or type.

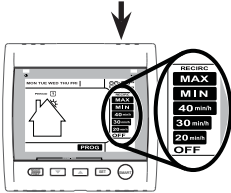

Ventilation speeds and type will flash.

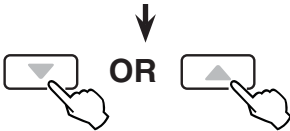

Use the arrow keys to select the ventilation speed or type.

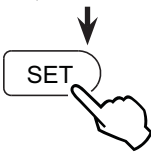

Press SET key to confirm the choice and go to setting daily period 2.

Period 2 will appear on screen and hour display will flash. Proceed as for Period 1 for all daily periods. Once the ventilation speed or type for Daily Period 4 has been selected:



Press SET key to confirm and go to weekend days.

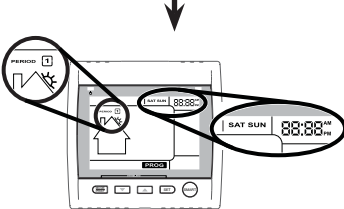

Weekend days and period 1 will appear on screen and hour will flash.

Set weekend days periods as for week days.

TO EXIT SETTING PERIODS



Press SET key for 3 seconds.

2. CONTROLS (CONT'D)

2.4 DECO-TOUCH MAIN CONTROL (ALL UNITS)

BACKLIGHT

If the backlight is not illuminated, the first button pressed (no matter which button) shall turn on the backlight. The backlight remains illuminated for 10 seconds after the last button pressed.



VC0119

OPERATING MODES

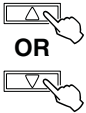

To change the operation modes of the ventilation unit, press the UP or DOWN arrow button. Operating mode label will then scroll up or down on LCD screen.

OFF

Put the unit on stand-by mode, so it will only respond to override wall controls (if present). On LCD screen, only the House is visible showing the control is powered on. This is the factory default mode.



RECIRC

Air is recirculated inside the house at high speed.

NOTE: This mode is not available for HRV Constructo 1.5V.



20 MIN/H

The ventilation unit exchanges air intermittently on a one hour cycle as follows: OFF for 40 min. (or recirculation* on high speed for 40 min., see next page) and then exchange air during 20 min. on low speed. Repeat cycle after the 20 min. of air exchange.

*Except for HRV Constructo 1.5V.



MIN

Air is exchanged with the outside on low speed.



MAX

Air is exchanged with the outside on high speed.



2. CONTROLS (CONT'D)

2.4 DECO-TOUCH MAIN CONTROL (ALL UNITS) (CONT'D)

HOW TO SET THE RELATIVE HUMIDITY (RH) LEVEL AND CHOOSE BETWEEN OFF IN STAND BY OR RECIRCULATION IN STAND BY*

Setting the relative humidity level allows to select the maximum desired indoor humidity level (in percentage). This value will be used to start the dehumidistat override (air exchange on high speed).

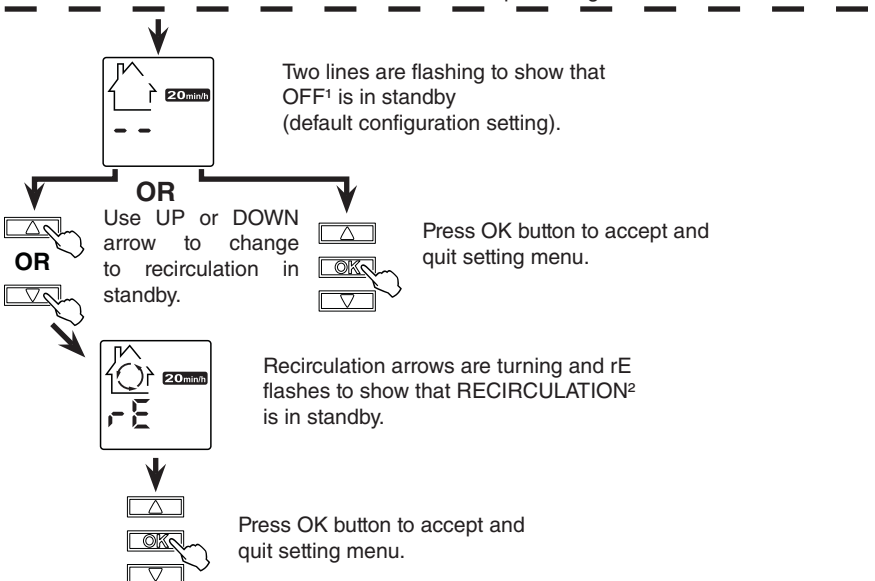
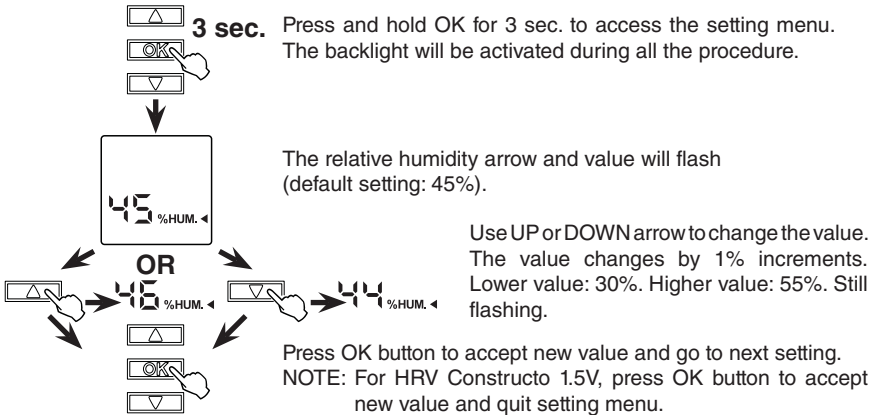

¹OFF IN STANDBY*: On 20 min./h. mode, the ventilation unit is OFF during 40 minutes and exchanges air with the outside on low speed during the remaining 20 minutes of the hour; this is the default value.

²RECIRCULATION IN STANDBY*: On 20 min./h. mode, the ventilation unit recirculates the inside air for 40 min. on high speed and exchanges air with the outside on low speed during the remaining 20 min. of the hour.

*OFF in standby and RECIRCULATION in standby are not available for HRV Constructo 1.5V units.

2. CONTROLS (CONT'D)

2.4 DECO-TOUCH MAIN CONTROL (ALL UNITS) (CONT'D)

DEHUMIDISTAT OVERRIDE SELECTION

In the operating modes MIN, MAX, 20 min./h. and RECIRC (if available), the user can select a dehumidistat override so that if the relative humidity (RH) in the house exceeds the RH setting previously stored, the ventilation unit will exchange in high speed until the target indoor RH setting is reached.

An air exchanger is not a dehumidifier, but it can change the indoor relative humidity by bringing in drier or more humid air from outside during non heating season. The dehumidistat override function is useful to reduce indoor RH when the outdoor air is cool and dry during the heating season. Select a target RH between 30% and 55% according to your comfort. When outdoor relative humidity is high (e.g. in summer), turn off the override by pressing OK until the RH display disappears.



When the dehumidistat override is activated, the AUTO indicator will appear on LCD screen to show that the actual mode is being overridden. Also, the relative humidity appears (if it was not shown, see example beside). Once the target humidity level is reached, the unit goes back into its original operating mode and AUTO disappears from LCD screen.

NOTE: If the actual mode is MAX, only the relative humidity level appears on screen, AUTO label will not appear.

To engage the humidity override, press OK. The actual indoor RH and the %HUM label appear on LCD screen.

NOTE: If the actual RH is less than 20%, then the humidity indicator will display "LO", and if the actual RH is greater than 80%, then the humidity indicator will display "HI".

To turn off the dehumidistat override, press OK again. The RH and %HUM display will disappear from LCD screen.

MAINTENANCE INDICATOR

The maintenance indicator is represented by an M in a rounded triangle, at the top of the house (see at right). If this indicator is flashing, perform the regular maintenance, and if it is not flashing, perform the annual maintenance (refer to Section 3).

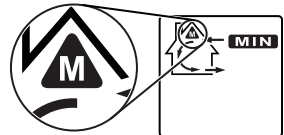

RESETTING MAINTENANCE INDICATOR: Press simultaneously on both arrow buttons, maintenance indicator will disappear from LCD screen.



POWER FAILURE

After a power failure, the wall control returns to its original operation mode. All settings are kept in memory.

2. CONTROLS (CONT'D)

2.5 LITE-TOUCH CONSTRUCTO MAIN CONTROL (FOR HRV CONSTRUCTO 1.5V UNIT ONLY)

Activate the push button; the color of the indicator shows the unit operating mode.

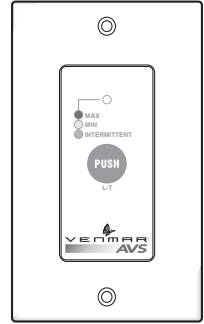

VC0075

Color	Mode	Suggested Use
GREEN	Intermittent	Select this mode when you are away from the house for a few days. Also, when you deem the inside air is too dry in heating season, or too humid during cooling season. In this mode, the unit is OFF for 40 minutes per hour and ventilates at minimum speed the remaining 20 minutes of the hour.
YELLOW	Min Speed Ventilation	For normal daily operation.
RED	Max Speed Ventilation	For excess pollutants and humidity (parties, odors, smoke, etc.)

2. CONTROLS (CONT'D)

2.6 CONSTRUCTO MAIN CONTROL (FOR HRV CONSTRUCTO 1.5V UNIT ONLY)

Adjusting AIR SUPPLY CONTROL

- 1) Select "MIN" or "MAX" using slide switch (A).
 - When "MIN" (minimum speed) is selected, if the knob (B) is set above the click, the unit will exchange in low speed with the outside and if it is set below the click, the unit will exchange on high speed with the outside until the desired humidity level has been reached.
 - When "MAX" (maximum speed) is selected, the unit will exchange on high speed with the outside either if the knob is set below or above the click.
- 2) To **turn off the unit**, slide the switch at the "OFF" position.

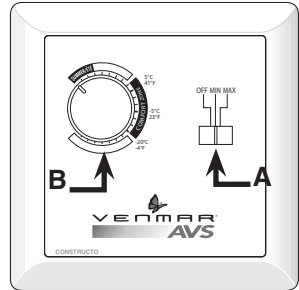

Adjusting DEHUMIDISTAT

Setting during the summer months:

During this period, unless being afflicted with breathing problems, using the Dehumidistat is unnecessary. Set the slide switch to "OFF" (Do not exchange in day time; exchange at night time, if cool outside, or if it is not raining.)

Setting during the fall, winter and spring months:

(When severe condensation appears on windows)

- 1) Determine the humidity level in your house (bring the knob (B) counterclockwise to its maximum position, then bring it back clockwise slowly until you hear a "click").
- 2) Set the knob to one line under this temperature level or "click"

CAUTION

Do not select a temperature below -20°C (-4°F). This could lead to excessive dryness in the air causing discomfort for the occupants.

It is possible (and normal) to experience condensation on your windows when drastic changes in temperature happen (for example: -5°C [23°F] to -20°C [-4°F]). In that case, we suggest waiting a few days to allow the situation to stabilize.

2.7 OPTIONAL AUXILIARY CONTROLS

Contrary to the main controls, up to 5 optional auxiliary controls can be connected to the same ventilation unit.

2.7.1 20-MINUTE LIGHTED PUSH-BUTTON (FOR HRV CONSTRUCTO 1.5V UNIT ONLY)

Press once to activate the push button. The unit will operate on high speed for 20 minutes and the indicator will light up. To stop activation before the end of the 20-minute cycle, push one more time. The unit will get back to its previous setting.

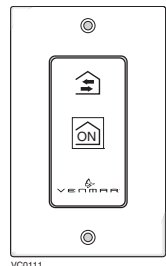

2. CONTROLS (CONT'D)

2.7 OPTIONAL AUXILIARY CONTROLS (CONT'D)

2.7.2 20/40/60-MINUTE PUSH-BUTTON TIMER (FOR AVS HRV EKO 1.5, AVS ERV EKO 1.5 AND NOVOFIT 1.0 UNITS ONLY)

Location: Located in the bathroom or in other locations where there is temporary humidity excess or pollutants.

Purpose: To eliminate excess humidity produced by showers or other periodic activities producing pollutants.

Within 2 seconds, push once for 20 minutes, twice for 40 minutes or three times for a 60-minute activation.

Results expected:

1. Motor speed: high for 20, 40 or 60 minutes.
2. Indicator light goes "ON" and flashes every 5 seconds (once to indicate a 20-minute operation, twice for a 40-minute, and three times for a 60-minute operation).
3. Air exchange indicator light goes "ON"

NOTE: To stop activation, push one more time.

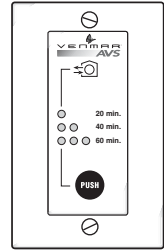

2.7.3 DEHUMIDISTAT (FOR HRV CONSTRUCTO 1.5V UNIT ONLY)

Adjust knob to the desired maximum indoor humidity level.

CAUTION
Do not select a humidity level below 30%. This could lead to excessive dryness in the air causing discomfort for the occupants.

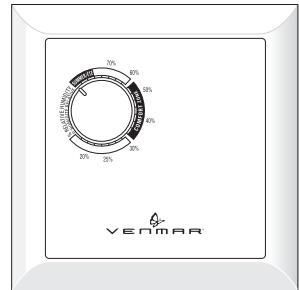

2.7.4 60-MINUTE CRANK TIMER (ALL UNITS)

This control makes the system operate at high speed for periods varying from 10 to 60 minutes.

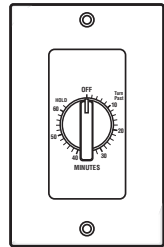

3. MAINTENANCE

⚠ WARNING

Risk of electric shock. Before performing any maintenance or servicing, always disconnect the unit from its power source. When cleaning the unit, it is recommended to wear safety glasses and gloves.

Refer to illustration at right to identify the inner parts of your unit.

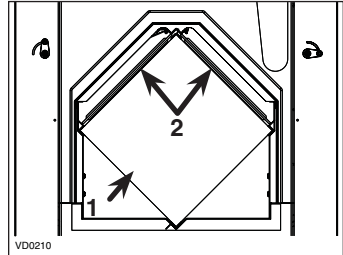

1) HRV or ERV core 2) Core filters

3.1 SEMI-ANNUAL MAINTENANCE

1. Turn the unit off and unplug the unit.

2. Remove the unit door by following these steps:

A Remove both door lower mechanical screws 8-32x1" (1) and set aside.

B Open (2) and lift out the door (3).

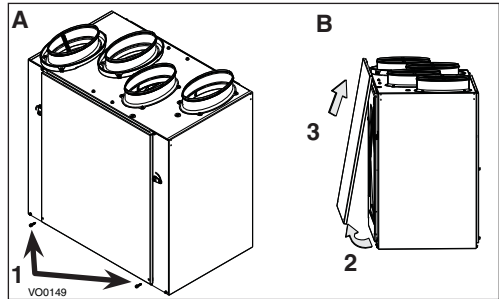

3. Slide out both filters (3) and the core (4) from the unit.
4. Clean the inside walls of the unit with a damp cloth, then wipe with a clean dry one.
5. Wash both core filters under hot water with mild soap. Rinse thoroughly and let dry completely before reinstalling on the core.
6. Remove the dust on the core using a vacuum cleaner and a soft brush attachment.

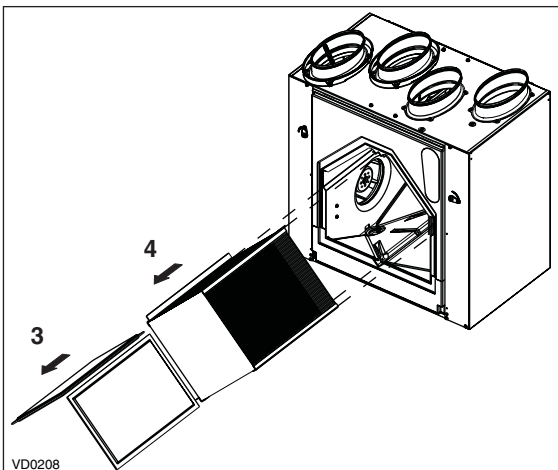

3. MAINTENANCE (CONT'D)

3.1 SEMI-ANNUAL MAINTENANCE (CONT'D)

CAUTION

Make sure to align proper symbol on the core (circle or square) with the one on the unit.

8. Slide the cleaned core into the unit.
9. Slide the cleaned filters into the unit.

NOTE: The mesh side of filters must be on bottom (rests on core surface).



10. Reinstall the door. Secure it with both mechanical screws 8-32 x 1" previously removed, plug back the unit and turn it on.

NOTE: The unit will return to its previous setting after a 30-second delay for booting sequence.

3.2 ANNUAL MAINTENANCE

Do the same operations as the Semi-Annual Maintenance (Section 3.1). Then, clean the exterior hoods.

4. TROUBLESHOOTING

If the unit does not work properly, reset the unit by unplugging it for one minute and then replug it. If it still not working properly, refer to table below.

PROBLEMS		TRY THIS
1.	On Altitude wall control, there is no outside temperature displayed on screen .	<ul style="list-style-type: none"> At its very start-up or after a power failure, it takes some minutes before the outside temperature value appears on screen. Set the wall control on MIN or MAX in VENT mode. If the problem is not solved by the above, contact your installer.
2.	On Altitude or Deco-Touch wall control, error code E1 or E3 appears on screen.	<ul style="list-style-type: none"> Contact your installer.

4. TROUBLESHOOTING (CONT'D)

PROBLEMS		TRY THIS
3.	Nothing works.	<ul style="list-style-type: none"> • See if the unit is plugged in. • See if the unit is receiving power from the house circuit breaker or fuse.
4.	Condensation on windows (air too humid).	<ul style="list-style-type: none"> • See Controls Section on pages 4 to 17. • Leave curtains half-open to allow air circulation. • Store all firewood in a closed room with a dehumidifier or in a well ventilated room, or store the wood outside. • Do not adjust the thermostat of your heating system below 18°C (64°F).
5.	Inside air too dry.	<ul style="list-style-type: none"> • Temporarily use a humidifier. • See Controls Section on pages 4 to 17.
6.	Air too cold at the air supply grille.	<ul style="list-style-type: none"> • Check if the exterior hood is not blocked. • See Controls Section on pages 4 to 17. • Install a duct heater.
7.	The LED of the integrated control is blinking RED.	<p>a) HRV and ERV EKO 1.5 only: There is a problem with one of the motors. The unit is OFF. Contact your installer.</p> <p>b) HRV Constructo 1.5V and Novofit 1.0 only: There is a problem with the exhaust motor. The unit is OFF. Contact your installer.</p>
8.	The LED of the integrated control is blinking GREEN.	<ul style="list-style-type: none"> • There is a problem with the thermistor. The unit is still working, but will defrost frequently. Contact your installer.
9.	The LED of the integrated control is blinking AMBER.	<ul style="list-style-type: none"> • There is a problem with the motorized damper. The unit is OFF. For a 2½-hour period, the unit will try to reset the damper at every 30 minutes. After 2½ hours, if the problem is not solved, the unit stops trying to reset damper. Contact your installer.
10.	The integrated control push button does not work.	<ul style="list-style-type: none"> • The 30-second boot sequence is not completed. See Integrated Control on page 5.

If the problem is still not solved, call your installer or the nearest approved Service Center. Also, you can reach the Customer Service Department at the following phone number:
1-800-567-3855.

REPLACEMENT PARTS AND REPAIR

In order to ensure your ventilation unit remains in good working condition, you must use Venmar Ventilation Inc. genuine replacement parts only. The Venmar Ventilation Inc. genuine replacement parts are specially designed for each unit and are manufactured to comply with all the applicable certification standards and maintain a high standard of safety. Any third party replacement part used may cause serious damage and drastically reduce the performance level of your unit, which will result in premature failing. Venmar Ventilation Inc. also recommends to contact a Venmar Ventilation Inc. certified service depot for all replacement parts and repairs.