

SPECIFICATIONS

MODEL	V30 SERIES
VOLTS	120 VAC
HZ	60
AMPS	2.2
CFM (VERT.)	310
CFM (HORIZ.)	390
SONES (VERT.)	8.5
SONES (HORIZ.)	8.0
TOTAL HOOD POWER CONSUMPTION	259 W
DUCTING SIZE	6" ROUND* OR 3 1/4" x 10"
2 SHIELDED HALOGEN BULBS	MR16 OR PAR16, 50 W, GU10 BASE
WARRANTY	5 YEARS

*3 1/4" x 10" TO 6" ROUND TRANSITION SOLD SEPARATELY.

DIMENSIONS

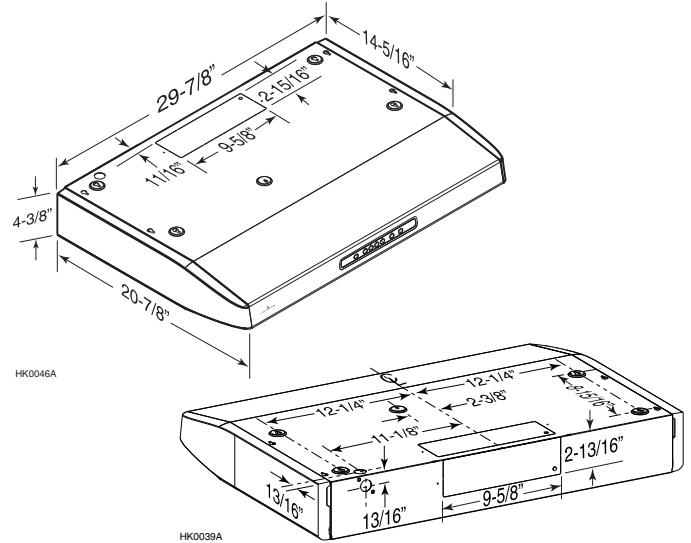

REQUIREMENTS & STANDARDS

- Complies with the CSA C22.2 no. 113 Standard
- Complies with UL 507 requirements

AIR FLOW PERFORMANCE

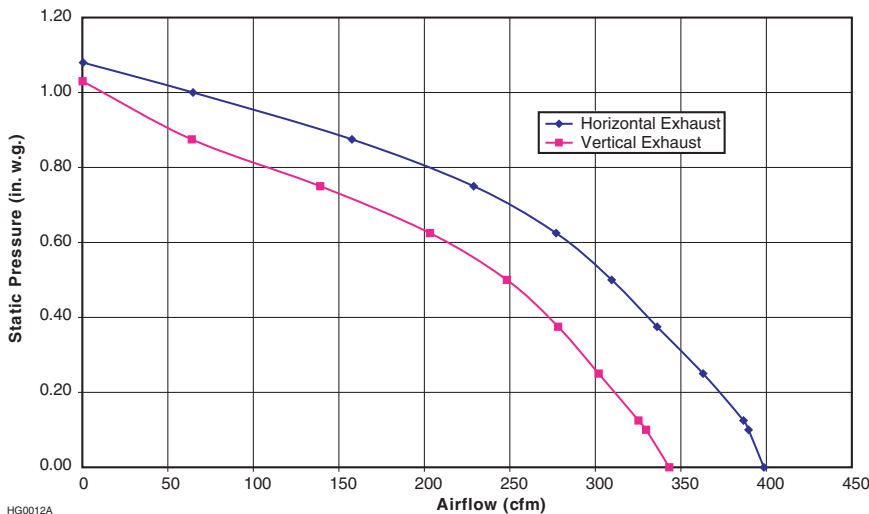

HG0012A

www.venmar.ca

Venmar Ventilation Inc., 550 Lemire Blvd., Drummondville, Québec, Canada J2C 7W9 - Tel.: 1-800-567-3855 Fax: 1-800-567-1715



HVI-2100 CERTIFIED RATINGS comply with new testing technologies and procedures prescribed by the Home Ventilating Institute, for off-the-shelf products, as they are available to consumers. Product performance is rated at 0.1 in. (2.54 mm) static pressure, based on tests conducted in a state-of-the-art test laboratory. Sones are a measure of humanly-perceived loudness, based on laboratory measurements.

PROJECT	REMARKS
LOCATION	
MODEL No.	
QTY.	
SUBMITTED BY	
DATE	